





BRITISH MADE STOVES SINCE 1972

It was in 1972 when, along with my father and older brother, we set up a small engineering business in Niton on the Isle of Wight. In those days we ran a repair shop and fabricated balustrades, gates and even hotel fire escapes. In the mid seventies Dutch Elm Disease ravaged the country killing an estimated 25 million trees. Simultaneously a hike in oil prices caused the cost of heating to escalate. These two factors combined to kick start the market for woodburning stoves in the UK. We saw a need for a small model for the local market so we fabricated our first stove *The Beacon*. Persuaded to exhibit at a specialist stove show in Welwyn we received orders from all over the UK which established us as

a serious stove manufacturer. Today selling under the brand name Charnwood, to many countries worldwide, employing 180 staff including second and third generation family, we manufacture stoves that exceed the highest standards set for efficiency and emissions. In our 50 years we have learnt three things that are vital to us:

- *Faith in God*
- *Make products we can believe in*
- *Value the people we work with, our customers and suppliers*

Take any one of those away and we wouldn't have made it!

John Wells • Founder of A.J Wells & Sons Ltd.



INTRO

INTRODUCTION	4
CLEAN BURN HEATING	6

STOVES

CRANMORE	10
CRANMORE 5	12
CRANMORE 7	14
AIRE	16
AIRE 3	18
AIRE 5	20
AIRE 7	22
SKYE	24
SKYE 5	26
SKYE 7	28
ARC	30
ARC 5	32
ARC 7	34
COVE	36
COVE 2	38
COVE 3	40
ISLAND	42
ISLAND I	44
ISLAND II	46
ISLAND III	48
BAY	50
BAY VL	52
BAY BX	54
C-SERIES	56
C-FOUR	58
C-FOUR INSERT	60
C-FIVE	62
C-SIX	64
C-SEVEN	66
C-EIGHT	68
THE BEMBRIDGE	70
COUNTRY 4	72

INNOVATION

CONVERTING GRATE	76
DROP-IN GRATE	76
QUATTROFLOW® SYSTEM	76
CHARNWOOD FLUE	76
HEATSHIELDS	77
DROP-DOWN THROAT PLATE	77
FLUE BOILERS	77
REAR FLUE ADAPTOR	77
EXTERNAL AIR KITS	77
COOKING PLATE	77
STOVE POD	78
COLOUR	80
STOVE SELECTOR	82
COMPARISON CHART	83
VLAZE	84

SPECIFICATIONS

CRANMORE	88
AIRE	88
STOVE POD	88
SKYE	89
ARC	90
ISLAND	90
COVE	91
BAY	92
C-SERIES	92
THE BEMBRIDGE	94
COUNTRY 4	94

FIRESIDE ACCESSORIES

ACCESSORIES	98
MOISTURE METER	98
ASH-CARRIER	98
STOVE PIPE THERMOMETER	98
TOASTING FORK	98
FIRE BALL	98
BODJ FAIR TRADE	100
CHARNWOOD LIVE FIRE	102



FOLLOW @CHARNWOODSTOVES





EXCEPTIONAL BRITISH MADE STOVES

CHARNWOOD is a privately owned family business based on the Isle of Wight. Established in 1972 we have become one of the foremost stove companies in Europe specialising in the manufacture of fine fires and stoves. As a company we believe in taking a strong ethical approach to every area of our business; whether it be in how we design and build our stoves, how we treat our customers or the impact our products have on the environment.

Our stoves are designed and built to last. Even fifty years after manufacturing our first stove there are still many of our original models giving good service as they continue to heat peoples' homes. We believe that this is how it should be; an investment in a Charnwood is more than just a short term relationship.

Our company ethos includes buying, where possible, from local UK based suppliers. Our stoves are designed, and built in our factory here on the Isle of Wight and are manufactured using a combination of high-tech precision machinery and skilled hand work. We have employees who have been with us for well over 40 years and have seen the company grow from an operation producing a few hundred stoves a year to one making tens of thousands of units that are sold worldwide. Affirming this achievement, we were awarded The Queen's Award For Enterprise: International Trade in 2009.

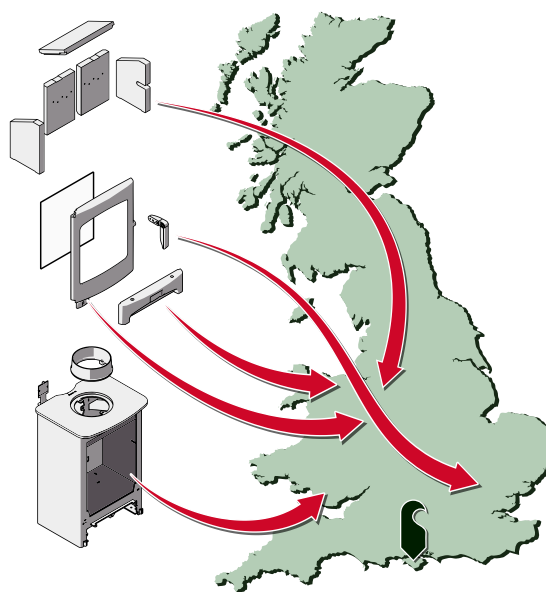

Part of the success of Charnwood has been due to the loyal following of our customers. We always aim to give first class service and ensure all our customers' needs are met. Whether it is for installation advice, reassurance on operation or the need for spare parts we always strive to put the customer first. As a family business, with ten family members working in the company, we recognise the need for personal attention to detail and we always seek to give just that.

CLEAN BURN WOOD & MULTI-FUEL HEATING

There is nothing quite like heating your home with a real Charnwood fire. Not only does the ritual of loading a stove give a greater sense of achievement and satisfaction, it provides a warmth that no other energy source can equal.

We at Charnwood have unrivalled in-depth knowledge of real-fire heating and continue to invest a great deal of time and money into innovative stove design and development. Our appliances are a result of our intense research and over the years we have been at the forefront of the new generation of clean burning ultra efficient stoves. We are leading the way in Ecodesign Ready stoves as new regulations coming into force in 2022. Our stoves are advanced appliances that deliver a reliable burn providing warmth to the whole of your property and all with an amazing degree of control, economy and environmental friendliness. The bodies of our stoves are British built from the best combination of materials for

durability and design aesthetics: plate steel, cast iron, fire brick and ceramic glass. These materials offer the best in strength and versatility with excellent heat retention properties. They also allow the stove to be tightly sealed ensuring optimum control over the burn rate - close down the air supply for a gentle burn or open it right up for an intense, blazing fire. The throat plate on all of our models can be taken out with ease, enabling the cleaning of the flueways and the chimney without the inconvenience of removing other internal fireparts. All our stoves are designed and tested to EN13240:2001 and EN13229:2001, ensuring the very best in efficiency, safety, design and construction.





CLEARSKIES MARK • Charnwood offer a wide range of stoves that are all clearSkies certified and feature our revolutionary BLU technology. This helps to significantly reduce particle emissions while ensuring high efficiencies, easy and controllable operation all with a superior flame picture. clearSkies is a UK-wide programme to help lower emissions and improve air quality. A clearSkies certified stove demonstrates the appliance meets and exceeds Ecodesign standards. A clearSkies level 3 appliance meets Ecodesign standards and includes Defra exemption, a clearSkies level 4 is a 15% improvement on Ecodesign standards and is Defra Exempt and a clearSkies level 5 is a 15% improvement on level 4 and Defra exempt. clearSkies certified stoves are the most environmentally friendly stoves available on the market today and benefit from:

- *Low Particle Emissions: 90% better than open fires*
- *Between 80-84% better than older stoves*
- *Low CO emissions*
- *High efficiencies*
- *Improved flame picture*

CLEAN-BURN AIR-WASH • All the wood-burning and multi-fuel stoves featured in this brochure incorporate the latest clean-burn and air-wash technology. This means when burning your choice of fuel the volatile by-products emitted by the initial burning are re-ignited and burnt again in the fire. This double combustion drastically reduces emissions and ash deposits and delivers even more warmth to your room. Altogether a cleaner home, a cleaner chimney and much cleaner for our environment. In addition to this, the clean-burn airwash also keeps the

glass doors beautifully clear, giving you an uninterrupted view of the fire.

10 YEAR GUARANTEE & 1 YEAR NO-QUIBBLE CONSUMABLES GUARANTEE • When purchased through an official, authorised stockist and registered using the code given by them the bodies of our stoves are covered by a 10 year guarantee. Additionally we offer a 1 year no-quibble guarantee for all consumables. This includes glass, fire brick and rope seals. For stoves not registered using the code a standard 1 year guarantee is available, which does not include consumables. Visit our website or speak to your stockist for further details and terms and conditions.

VERSATILITY • Within the Charnwood range there is a model to suit every home requirement. For the ultimate in contemporary home heating we offer the Aire, the Skye, the Arc, the Cove and the Bay. For a classic interior we offer the Cranmore, the Island, the C-Series, the Bembridge and the Country 4.

ENVIRONMENT • Governments across the world are committed to reducing CO₂ emissions and with a Charnwood you too can play a part in this. When you burn wood on a highly efficient stove you reduce the need for other forms of heating and in turn do your bit to save fossil fuels, CO₂ emissions and the planet! A Charnwood stove also gives you the freedom from dependence on the large energy utilities. At a time when there is increasing concern over stability of supply throughout the world it is nice to know that a Charnwood gives that certainty of warmth during periods of interrupted supply.



STOVES

WOOD AND MULTI-FUEL

unrivalled and uncompromised



charnwood CRANMORE

Traditional styling, innovative design: A modern classic

This latest stove collection takes inspiration from the Regency era with a single framed glass door and archetypal detailing. The pleasing proportions of the Cranmore make it well suited to a traditional fireplace and with a large picture window it is an ideal replacement for an open fire. The stove can also work equally well in a freestanding situation.

Available in 2 sizes the Cranmore uses Charnwood clean burn Blu technology and is exceptionally efficient with a clearSkies level 5 rating.

New firebrick and air technology produces a mesmerising flame pattern.

A single door frames the fire

Sliding firebed for clean and easy ash removal

One single air control using the patented Quattroflow® air management system.



The Cranmore has been independently certified to conform to EN 13240:2001 and meets the UK building requirements for installation with a 12mm non-combustible hearth.





cranmore 5

The Charnwood Cranmore 5 provides 2-5kW of heat to the room with a beautifully clear view of the fire. While classic in style the stove features the very latest in clean burn technology. Perfect for period properties that are looking for a sustainable and environmental form of room heating.





cranmore 7

The Charnwood Cranmore 7 is designed for spacious rooms and living areas with a hearty 7kW output. The stove features one single door that elegantly frames the large view of the fire.



charnwood AIRE

A mesmerising flame pattern with a crystal clear burn

The Charnwood Aire is a range of simply styled wood burning stoves. Designed with a very large view of the fire we have also incorporated new and improved burn technology that not only meets and goes beyond the new 2022 Ecodesign standards and Defra exemption requirements but delivers one of our most impressive flame pictures.

The Aire is available in 3 sizes with low or store stand models to choose from in a choice of eight colours.

Innovative airflow technology produces an exceptional clean-burn flame pattern.

Large view of the fire

Sliding firebed for clean and easy ash removal

Beautifully simple to operate with one single air control using the patented Quattroflow® air management system.



CE The Aire has been independently certified to conform to EN 13240:2001 and meets the UK building requirements for installation with a 12mm non-combustible hearth.





aire 3

This British made stove is an exciting addition to our Charnwood Aire collection. With a 3.6kW output delivering an impressive efficiency of 84% the Aire 3 has been designed for smaller spaces. Not just for conventional houses - but for cabins, house boats, yurts and other types of tiny homes.

We also offer a standalone hearth and chamber enclosure for this model; the Charnwood Stove Pod (see page 78).





aire 5

The Chamwood Aire 5 delivers a comfortable 2-5kW of heat to the room with a crystal clear burn and remarkable controllability. Deliberately designed to maximise the view of the fire the minimal styling of the Aire fits comfortably into virtually any fireside situation whether it be freestanding or within a traditional fireplace.





aire 7

The Charnwood Aire 7 offers an impressive 7kW output and has been designed for larger rooms or open plan areas. Featuring one of our largest ever picture windows the Aire 7 burns with a mesmerising flame pattern that is second to none.



*Opposite: Aire 7 Low in black on Vlaze hearth plate in quilted graphite
Above L-R: Aire 7 Low, Aire 7 Store Stand*

charnwood SKYE

Refreshingly simple to use with an exceptional clean burn

The Charnwood Skye is a state-of-the-art multi-fuel stove with a remarkably efficient combustion system. It's innovative burn technology ensures efficiencies of up to 86% and is a vast improvement on the new Ecodesign standards and Defra exemption requirements; allowing wood to be burnt cleanly in smoke control areas. As thoughtful in style as it is in function the Skye has a refreshing design aesthetic – it is classically minimal with landscape proportions and a soft modern edge.

The Skye is available in two sizes: a 5kW and 7kW both in a choice of eight colours and in two stand variations: low or with a store stand.

The Skye's clean design features a seamless flue connection and convection panels to reduce distances to combustible materials; allowing installation into tight spaces.

Flexible fuel choice with an adjustable converting grate for wood and smokeless fuels.

Simple to operate with one single air control using the patented Quattroflow® air management system.



The Skye has been independently certified to conform to EN 13240:2001 and meets the UK building requirements for installation with a 12mm non-combustible hearth.





skye 5

The Charnwood Skye 5 is our most efficient wood burning and multi-fuel stove to date. With a rated output of 5kW it delivers a comfortable 2-5kW of heat to the room with an exceptional clean burn. The simple, modern styling of the Skye ensures it looks equally as good in a freestanding situation as it does in a fireplace.





skye 7

The Charnwood Skye 7 adds an air of contemporary grandeur to any open plan area or room of larger proportions. With a rated output of 7kW it will produce between 5-11kW of heat with a generous view of the fire.



Opposite: Skye 7 Low in black on Vlaze hearth plate in black
Above L-R: Skye 7 Low, Skye 7 Store Stand

charnwood ARC

The stove of a new generation: clean, green and fuel efficient

The Charnwood Arc is a revolutionary multi-fuel stove. It simplifies the process of burning wood and smokeless fuels setting the benchmark for a new generation of modern, clean-burning stoves.

Engineered from the very best combination of materials the Arc utilises years of research and development into low emission burning.

Beneath the Arc's clean, modern lines lies an innovative combustion system that ensures the stove burns exceptionally clean with outstanding efficiencies of over 80%. The Arc is clearSkies certified and Defra exempt; allowing wood to be burnt in smoke control areas.

The Arc is available in two sizes: a 5kW and 7kW both in a choice of eight colours and in two stand variations: low or with a store stand.



CE The Arc has been independently certified to conform to EN 13240:2001 and meets the UK building requirements for installation with a 12mm non-combustible hearth.



Convection panels reduce rear distance to combustibles to 80mm allowing installation into tight spaces.

Flexible fuel choice with our adjustable converting grate for wood and multi-fuel.

Simple to use with single air control, our patented Quattroflow® air management system and integrated external air connection.

Optional drawer

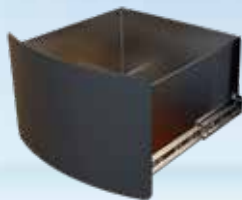

arc 5

The Charnwood Arc 5 produces between 2-7kW of heat with a rated output of 5kW. Operated by one single air control the combustion system drastically reduces emissions and gives a superior flame pattern. The Arc's pared down simplicity makes for a thoroughly stylish option for modern urban settings as well as more traditional homes.





arc 7

The Charnwood Arc 7 delivers an output of 7kW and is particularly suited to larger rooms or open plan areas. It is a true multi-fuel stove with exceptional clean burn technology. The Arc 7's contemporary design features an inverted flue collar for a seamless flue connection.





charnwood COVE

Optimum performance with a soft, contemporary aesthetic

The Cove is one of Charnwood's most revered range of wood burning stoves: a union of the very best features of our past and present stoves finished with a soft contemporary edge. One single, curved door offers a breathtaking view of the fire whilst its highly advanced combustion system ensures optimum efficiency and an exceptionally clean burn - more heat from less fuel.

Whilst the Cove is sophisticated in design, it is incredibly simple to operate. One multi-functional tool is used to open the door, de-ash and empty.

The Cove features Charnwood's un-rivalled converting grate, advanced clean burn technology and the patented Quattroflow® air management system. An optional external air kit is also available enabling an outside air supply to be channelled directly into the stove through the rear of the Quattroflow® box. The Cove stove is available in two sizes with a choice of five base options and eight Charnwood Colours. Optional convection panels are also available for each of the stoves. These gently convect heat into the room and reduce the side distances to combustables to 250mm.



The Cove has been independently certified to conform to EN 13240:2001 and meets the UK building requirements for installation with a 12mm non-combustible hearth.



Optional side convection panels & rear heat shield



Two outputs



Five base options



Converting grate



Quattroflow[®] air management system



COVE 2

With its gentle curved door and soft lines the Charnwood Cove 2 creates a powerful focal point for any room. This stove delivers a respectable 8kW of heat with a maximum output of 11kW and is Defra exempt; allowing wood to be burnt safely and cleanly in smoke control areas. The base options (as pictured opposite) give the stove five very different looks. The low stand and low arch are perfect for fitting the appliance into a standard fireplace opening whilst the store stand and centre stand are ideal for a large inglenook or a freestanding situation. Optional convection panels are also available.





COVE 3

The Charnwood Cove 3 is the largest stove in the Cove range. With a rated output of 12kW and a maximum of 16kW it is ideally suited to a larger room, hall or open plan area. The Cove 3 is able to take a log length of up to half a metre and with its tall curved door offers a spectacular view of the fire. Once again it comes with a versatile choice of five base options, convection panels and eight colour ways to suit different situations.





charnwood ISLAND

Our iconic two door stove: now updated

The iconic Charnwood Island range sets the standard for clean-burning multi-fuel stoves. When first launched, this collection revolutionised multi-fuel home heating and became the benchmark in clean-burning environmentally friendly single controlled stoves.

The updated Island range is clearSkies certified incorporating our Blu technology. The Island I and II are multi-fuel options that are based on the original design, but now feature cleaner lines and a larger picture window. The highly acclaimed Island III Blu has also been retained, though as a wood-burning option only.

The Island range is available in three sizes, with low leg, high leg or store stand options and in a choice of eight Charnwood Colours.





*The ultimate converting grate for burning
your chosen fuel at optimum efficiency*

*A 'cool to touch' handle for safe and easy
reloading.*

*One simple air control - the Quattroflow® -
push in to burn slower, pull out to burn faster.*



All Island stoves have been independently certified to conform to EN 13240:2001 and meet the UK building requirements for installation with a 12mm non-combustible hearth.

ISLAND I

The Charnwood Island I is the smallest stove in the Island collection. Its uncomplicated looks and gentle curves ensure it sits well in any situation; be it modern or traditional. Delivering an output of 2-7kW of heat it can take a log length of up to 370mm (14.5"). With a rated output of 5kW the All New Island I, in certain situations, can be installed without the need for external air. This stove is Defra exempt and boasts an efficiency of over 85% and an extremely low smoke particle level of 9mg/m³ (the Ecodesign limit is 40mg/m³).





ISLAND II

The Charnwood Island II is the middle stove in the Island collection. With a larger view of the fire it still retains its clean-line proportions while producing a rated 8kW of heat to the room. This stove is Defra exempt when burning wood in smoke control areas and burns with an efficiency of over 82% with an extremely low smoke particle level of 14mg/m³ (the Ecodesign limit is 40mg/m³).





ISLAND III

The Charwood Island III is the largest stove in the Island collection. Its majestic proportions make it ideal for larger rooms and open plan areas. Producing 11kW of heat, this wood-burning only stove can hold a sizable log length of over half a metre. The Island III offers a spectacular view of the fire; a true wide-screen experience. Optional convection panels are also available.





charnwood BAY

A modern insert or freestanding fire with innovative clean burn technology

The Bay is an award winning wood burning stove from Charnwood. The stove features a large landscape window. Delivering 5kW of heat to the room the Bay features our Blu burn technology and is incredibly simple to operate with one single air control and a cool-to-touch handle.

The Bay is available as a clean lined insert stove, the Bay VL, or a freestanding version, the Bay BX. This can either be placed directly on the hearth or on a choice of optional stands.

Both models meet the requirements for Ecodesign 2022 and are Defra exempt; allowing wood to be burnt in smoke control areas.

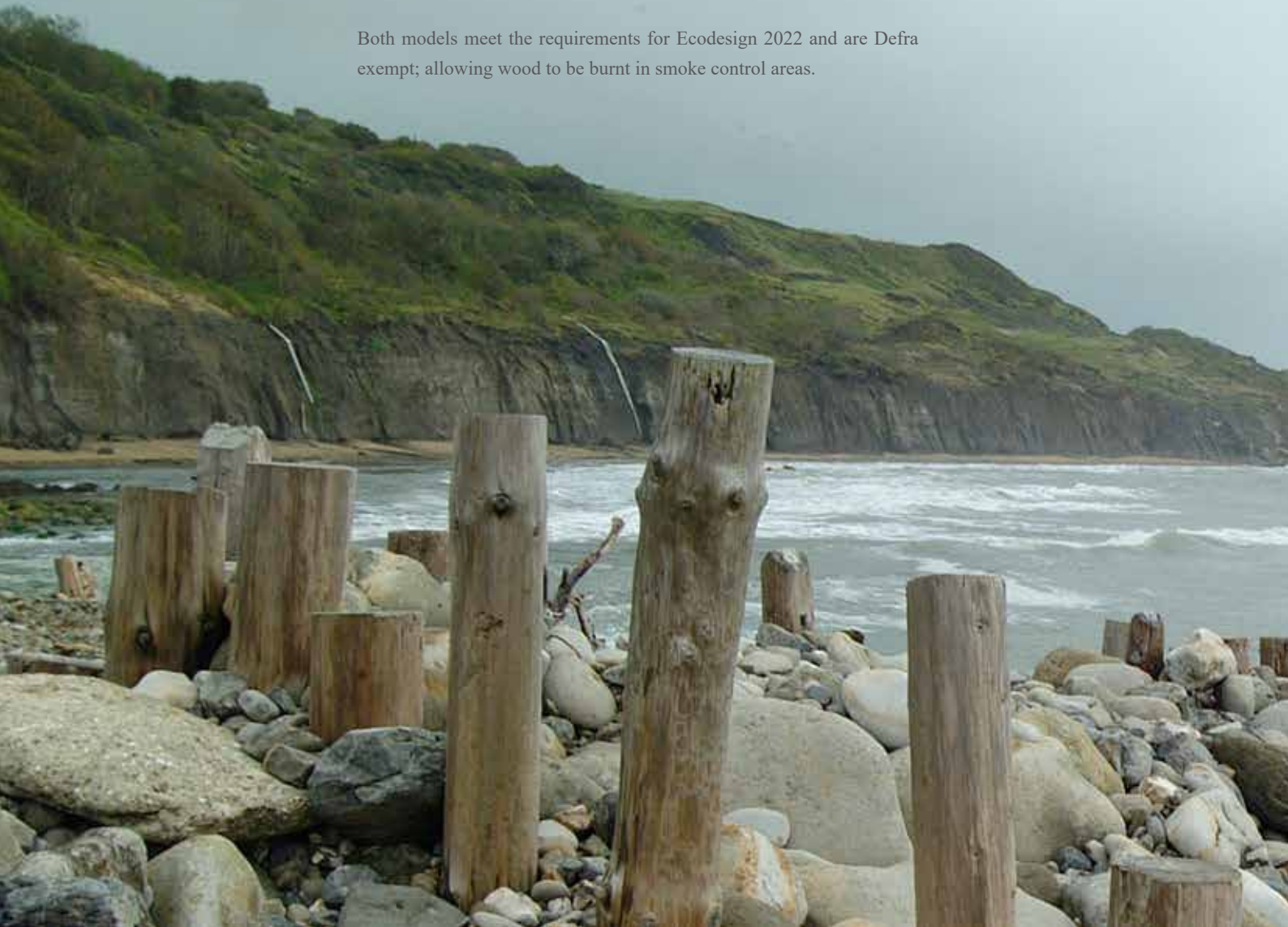

Built from the best combination of cast iron, plate steel and ceramic glass the Bay is brick lined and is designed for easy installation.

Cool-to-touch handle and air controls for safe operation and re-fuelling.



The Bay VL has been independently certified to conform to EN 13229:2001
The Bay BX is certified to conform to EN 13240:2001



BAY VL

The Charnwood Bay VL is a contemporary insert stove featuring a large landscape window framed with a clean, sharp edged surround. It is Defra exempt; allowing wood to be burnt in smoke control areas. The stove boasts a variable output of between 2 and 7kW and is available in a choice of eight colours.



BAY BX

The Charnwood Bay BX is the latest addition to the Bay range. The firebox and frame of the stove is the same as the Bay VL but features an outer casing transforming the appliance into a freestanding stove. The Bay BX can be installed directly onto a hearth or we offer a choice of three base options to raise the stove up: bench stand, centre stand or store stand. Both the stove and base options are available in eight colours.







charnwood C-SERIES

Quintessential Charnwood: Classic design with impressive performance

The C-Series is a range of classically styled wood burning stoves that feature one single air control and an integrated inlet for ducting external air to improve performance and efficiency.

The C-Series stoves deliver an exceptionally clean burn with outstanding efficiency and all models are Defra exempt; allowing wood to be burnt in smoke control areas. The C-Series stoves are all clearSkies certified and exceed the Ecodesign regulations. All models are available with an optional store stand or high legs to raise the stove off the ground. A rear heat shield is also available enabling the stove to be placed closer to the wall.

In addition to this range we also offer the C-Four Insert designed to fit neatly into a standard fireplace.



C-FOUR

Featuring a large picture window the Charnwood C-Four is the smallest model in the C-Series delivering a heat output to the room of between 2 to 5.5kW. The stove is fire brick lined and can take a log length of up to 282mm (11"). With a rated output of 4.9kW the C-Four, in certain situations, can be installed without the need for external air. This stove is Defra exempt; allowing wood to be burnt in smoke control areas.





C-FOUR INSERT

Based on the free standing Charnwood C-Four this stove is designed to fit into a standard fireplace. Featuring a single air control and an integrated outlet for ducting external air the C-Four Insert burns exceptionally clean with outstanding efficiency. This stove is Ecodesign Ready when burning either wood or solid fuels and features our renowned converting grate for efficient multi fuel burning. The C-Four Insert is also Defra exempt; allowing wood to be burnt in smoke control areas.

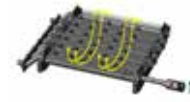





C-FIVE

The Charnwood C-Five has a similar output to the C-Four but it is built with landscape proportions to take a slightly longer log length; 351mm (14"). The stove is fire brick lined and in certain situations, can be installed without the need for external air due to its rated output of 5kW. This stove is Defra exempt; allowing wood to be burnt in smoke control areas.



*Opposite: C-Five in gunmetal
Above, L-R: C-Five, with store stand & high legs*

C-SIX

The Charnwood C-Six is a 5.9kW stove delivering between 5 and 7kW of heat to the room. The stove is fire brick lined and can take a log length of up to 307mm (12"). This stove is Defra exempt; allowing wood to be burnt in smoke control areas.





C-SEVEN

The Charnwood C-Seven, like the C-Five, is built with a wide picture window and landscape proportions to take a longer log length; 430mm (17"). The stove has a rated output of 7.1kW and is fire brick lined. This stove is Defra exempt; allowing wood to be burnt in smoke control areas.







C-EIGHT

The Charnwood C-Eight is the largest stove in the C-Series. With an 8kW output the stove features an impressive portrait picture window and takes a 366mm (14") log. With majestic proportions the C-Eight is suited to larger fireplaces and living spaces. This stove is Defra exempt; allowing wood to be burnt in smoke control areas.



*Opposite: C-Eight in gunmetal with store stand, Bodj Lotus log holder
Above, L-R: C-Eight, with store stand & high legs*



COUNTRY LIVING

The Bembridge

WOOD BURNING STOVE FROM CHARNWOOD

The Country Living Bembridge is an innovative wood burning stove made exclusively in partnership with Country Living magazine.

The Bembridge incorporates our latest *Blu* technology and is clearSkies level 5 certified exceeding Ecodesign regulations.

Featuring a removable door handle, one single air control and an integrated inlet for ducting external air, The Bembridge burns exceptionally clean with outstanding efficiency.

The stove is available in a choice of five colours including two colours exclusive to Country Living: Soft Green and French Grey.

The Bembridge is Defra exempt; allowing wood to be burnt in smoke control areas.

Other options include a store stand and high legs to raise the stove off the hearth, and a drop-in grate to assist with ash removal.



Opposite: *The Bembridge* in almond with store stand
Above L-R: Gunmetal, Almond, Soft Green, French Grey, Black
Optional store stand, optional high legs, optional drop-in grate





charnwood COUNTRY 4

A traditional, time-honoured stove

The Charnwood Country 4 is a neat, sturdy, yet graceful little fire and with a rated output of 5kW can be installed in certain situations, without the need for external air. The single door gives a complete, crystal clear view of the fire. In spite of its size, the Country 4 takes a decent sized log length of 332mm (13") making it a very popular choice in the small stove market. The stove is available in a choice of eight Charnwood colours and finished with touches of solid brass and a turned wooden door handle. The Country 4 *Blu* is Defra exempt; allowing wood to be burnt in smoke control areas.



CE The Country 4 has been independently certified to conform to EN 13240:2001

Opposite: Country 4 in almond
Above: Country 4 in black

A black dog, possibly a Labrador Retriever, is sitting on a dirt floor in a rustic, wooden structure. The dog is looking towards the right. In the background, there is a blue-painted wooden wheelbarrow filled with firewood. The walls are made of weathered wood. The overall scene is dimly lit, creating a warm, rustic atmosphere.

INNOVATION

SMART STOVE SOLUTIONS

refining the wood burning process



CONVERTING GRATE

The Charnwood multi-fuel converting grate is the very best grate system on the market. Built into all Skye, Arc, Island, Cove and C-Four Insert models, the grate can be altered to ensure the most efficient burning conditions. By operating a lever on the side of the stove, with the tool provided, a series of grate bars can be set into a closed, flat bed position (the most efficient way to burn wood) or to an open grate for ultra efficient burning where the stove is suitable for mineral fuel. This grate also acts as a highly effective riddling mechanism, neatly dropping the ash into the wall-to-wall pan below for clean disposal. Because the grate is operated externally all of these manoeuvres can be carried out with the doors closed and when the stove is fully loaded and under fire.

CLOSED POSITION for wood & peat - allowing a bed of ash to build up to let the air flow across the fire.



OPEN POSITION for smokeless fuels - allowing the air to flow up through the fuel.



Please note: the converting grate is also built into the Island III blu and Cove 2 blu but is designed for ash removal only and not multi-fuel burning.

DROP-IN GRATE

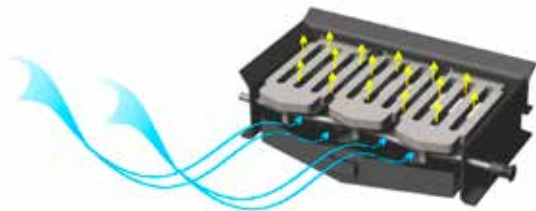

The Charnwood drop-in reciprocating grate is designed to assist with ash removal when burning wood. Its neat, external riddling action and ash pan ensure easy cleaning and keep mess to a minimum.

QUATTROFLOW® AIR MANAGEMENT SYSTEM

This is a revolutionary air management system patented by Charnwood and used on the Cranmore, Aire, Skye, Arc, Cove, Island, Bay, Bembridge and C-Series models. Using a number of air chambers the single control introduces the right amount of air into just the right places for ultra efficient burning and optimum control: pull out to increase the burning rate - push in to slow it down. An outside air supply can be channelled directly into the stove through the rear of the Quattroflow® box.

1 PRIMARY air vent: the main control for faster/slower burning

2 SECONDARY air vent for clean glass and double combustion

3 TERTIARY air vent for optimum combustion efficiency



CHARNWOOD FLUE

Charnwood offer a wide range of stove flue pipe pieces designed to complement the stove ranges. British made from 1mm 316 high quality stainless steel the range includes bends and adjustable lengths. Charnwood Flue is available in 5" (125mm), 6" (150mm) and 7" (178mm) diameters and in the full range of eight Charnwood colours.



HEAT SHIELDS AND CONVECTION PANELS

Charnwood's rear heat shields and convection panels are designed specifically for situations where space within the fireplace is limited. The steel heat shield allows minimum



rear wall clearances to be reduced. The heat shield is available in a number of sizes for the Cranmore, Aire, Cove, Island, C-Series, Bembridge and Country 4 blu. Speak to your local stockist or visit www.charnwood.com for further details.

DROP-DOWN THROAT PLATE

All Charnwood stoves are fitted with a drop-down throat plate allowing for the stove to be swept through the appliance saving time and with minimum mess.



FLUE BOILER

The Charnwood Flue Boiler replaces the first few feet of the standard flue rising from the top of the stove and utilises the excess heat from the appliance that would otherwise be lost. In addition to this because the boiler is external the stove maintains its high clean-burn combustion efficiency. Depending on the size of stove and subsequent flue boiler, outputs of between 1.8 and 3.4 kW can be achieved with minimal effect on the nominal output of the stove. This can provide sufficient heat for domestic hot water and up to 3 radiators. The flue boiler comes in 3 sizes to fit Cranmore, Aire, Arc 5, Cove, Island, C-Series, Bembridge and Country 4 models.



VERTICAL REAR FLUE ADAPTOR

A vertical rear flue adaptor is available for all Cranmore, Aire, Skye, Arc, Island, Cove, C-Series, Bembridge and Country 4 models. This enables you to position the stove further out into



the room and away from the wall behind. This will add a depth to the stove of between 115-196mm depending on the model. Speak to your local stockist or visit www.charnwood.com for further details.

EXTERNAL AIR KITS

The external air kit enables an outside air supply to be channelled directly into your Charnwood stove. As well as providing further comfort and operational efficiency for your stove our air kits help overcome issues where the room requires an additional air supply.



COOKING PLATE

The Charnwood Cooking Plate is a cast iron plate that simply replaces the blanking plate on a standard Charnwood stove to create a highly effective hot plate for cooking.



The Cooking Plate is ideal for stoves installed into open-plan living areas where the boundaries of cooking, dining and lounging are merged. The set includes four cast iron trivets for versatility when cooking and the plate is available in two sizes: 5 or 6 inch outlet diameters to suit most Charnwood models.

Please note: the stove will need to be installed using the rear outlet to allow the cooking plate to be fitted on the stove top.

charnwood STOVE POD

*An instant freestanding stove chamber & hearth plate
that is quick and easy to install.*

The Charnwood Stove Pod is a freestanding hearth and chamber enclosure designed for use with our Aire 3 wood burning stove. The Pod is a quick and easy way of creating an instant fireplace so is perfectly suited to cabins, yurts, houseboats and other types of tiny home accommodation.

The Charnwood Stove Pod can be safely placed 50mm away from combustible materials. It is finished in a durable black powder coat but we also offer the option of a VLAZE vitreous enamel in black and white or clay splatter finish to further enhance the enclosure.





charnwood COLOUR

In addition to the standard Charnwood matt black, we also offer you a choice of seven other shades. It is a simple yet brilliant way to give the heart of your home a new lease of life. Either order your stove in the colour of your choice or purchase one of our paint kits to re-spray the stove yourself whenever you feel like a change.



black



blue



brown



green



almond



bronze



gunmetal



pewter

Charnwood Colour is a specially developed, high temperature stove paint formulated for an easy application. It is suitable for the following stoves in the Charnwood range: Cranmore, Aire, Skye, Arc, Cove, Island, Bay, C-Series and Country 4. The Bembridge is available in Black, Almond and Gunmetal and two exclusive Country Living colours.

Please note: we have reproduced the colours as faithfully as print will allow however the pictures should not be taken as an exact indication of colour.







C-Four in Bronze

CHOOSING YOUR **charnwood**

When choosing your stove it is important to pick the right size stove for your room by taking into account the RATED OUTPUT: This is the kilowatt output achieved in the European standard tests (EN 13240 and EN13229). Use this chart or our simple calculator on our website as an initial guide in selecting the most suitable Charnwood stove for your room. It is based on an outside temperature of -1°C and a room height of 2.4 metres.

PLEASE NOTE: This is an approximate guide only. Your Charnwood Premier Dealer will be able to advise further.

2.5												
3.0												
3.5												
4.0												
4.5												
5.0												
5.5												
6.0												
6.5												
7.0												
7.5												
ROOM SIZE IN METRES	2.5	3.0	3.5	4.0	4.5	5.0	5.5	6.0	6.5	7.0	7.5	

	AIRE 3, SKYE 5, C-FOUR, C-FOUR INSERT, C-FIVE, THE BEMBRIDGE, COUNTRY 4
	CRANMORE 5, AIRE 5, ARC 5, BAY VL, BAY BX, ALL NEW ISLAND I, C-SIX
	CRANMORE 7, AIRE 7, ARC 7, SKYE 7, COVE 2, ALL NEW ISLAND II, C-SEVEN, C-EIGHT
	COVE 3, ISLAND III

charnwood COMPARISON CHART

FEATURES	STOVE MODEL																								
	CRANMORE 5	CRANMORE 7	AIRE 3	AIRE 5	AIRE 7	SKYE 5	SKYE 7	ARC 5	ARC 7	THE BEMBRIDGE	BAY BX	BAY VL	COVE 2 Blu*	COVE 3 Blu*	ISLAND I	ISLAND II	ISLAND III Blu*	C-FOUR Blu	C-FOUR INSERT	C-FIVE Blu	C-SIX Blu	C-SEVEN Blu	C-EIGHT Blu	COUNTRY 4 Blu	
Wood Burning	Standard	Standard	Standard	Standard	Standard	Standard	Standard	Standard	Standard	Standard	Standard	Standard	Standard	Standard	Standard	Standard	Standard	Standard	Standard	Standard	Standard	Standard	Standard	Standard	Standard
Multifuel						Standard	Standard	Standard	Standard											Standard					
Converting grate						Standard	Standard	Standard	Standard																
Drop-in grate										Optional										Optional		Optional	Optional	Optional	Optional
Quattroflow® / Single control	Standard	Standard	Standard	Standard	Standard	Standard	Standard	Standard	Standard	Standard	Standard	Standard	Standard	Standard	Standard	Standard	Standard	Standard	Standard	Standard	Standard	Standard	Standard	Standard	Standard
Convection panels						Standard	Standard	Standard	Standard																
Vertical rear flue adaptor	Optional	Optional	Optional	Optional	Optional	Optional	Optional	Optional	Optional	Optional	Optional	Optional	Optional	Optional	Optional	Optional	Optional	Optional	Optional	Optional	Optional	Optional	Optional	Optional	Optional
Heat shield						Standard	Standard	Standard	Standard																
External air kit						Optional	Optional	Optional	Optional	Optional	Optional	Optional	Optional	Optional	Optional	Optional	Optional	Optional	Optional	Optional	Optional	Optional	Optional	Optional	Optional
Riddling grate & ash tray	Standard	Standard	Standard	Standard	Standard	Standard	Standard	Standard	Standard											Standard					
Stand / Leg options			Optional	Optional	Optional	Optional	Optional	Optional	Optional		Optional									Optional		Optional	Optional	Optional	Optional
Stay cool handle	Standard	Standard	Standard	Standard	Standard	Standard	Standard	Standard	Standard		Standard	Standard								Standard	Standard	Standard	Standard	Standard	Standard
Removable handle										Standard															
Firebrick lining	Standard	Standard	Standard	Standard	Standard	Standard	Standard	Standard	Standard	Standard	Standard	Standard	Standard	Standard	Standard	Standard	Standard	Standard	Standard	Standard	Standard	Standard	Standard	Standard	Standard
Drop-down throat plate	Standard	Standard	Standard	Standard	Standard	Standard	Standard	Standard	Standard	Standard	Standard	Standard	Standard	Standard	Standard	Standard	Standard	Standard	Standard	Standard	Standard	Standard	Standard	Standard	Standard
Flue boiler	Optional	Optional	Optional	Optional	Optional			Optional	Optional	Optional	Optional	Optional	Optional	Optional	Optional	Optional	Optional	Optional	Optional	Optional	Optional	Optional	Optional	Optional	Optional
Front shelf																									Optional
Double doors																Standard	Standard	Standard							
Defra exempt	Standard	Standard	Standard	Standard	Standard	Standard	Standard	Standard	Standard	Standard	Standard	Standard	Standard	Standard					Standard	Standard	Standard	Standard	Standard	Standard	Standard
(EPC) Energy Efficiency Rating	A+	A+	A+	A+	A+	A+	A+	A+	A+	A+	A+	A+	A	A	A+	A+	A	A	A+	A	A+	A	A	A	A+
clearSkies mark	5	5	5	5	5	5	5	5	5	5	5	5	4	2	5	5	2	5	5	5	5	5	5	5	5
Nominal output to room (kW)	5	7	3.6	5	7	5	7.3	5	7	5	5	5	8	12	5	8	11	4.9	5	5	5.9	7.1	8	5	

 Standard

 Optional

* Please note: the Converting grate used in these models is for woodburning ONLY to assist with ash removal.



VLAZE

Luxurious vitreous enamel for the fireplace

VLAZE offer a range of vitreous enamel wall cladding and hearth plates designed specifically for the fireplace. British made by our sister company AJ Wells, the exceptional surface finish is created by fusing powdered glass to steel at temperatures in excess of 800°C. The result is a luxurious, vibrant glaze that boasts excellent thermal properties, does not crack, distort or discolour when exposed to the heat of the stove and wipes clean. The VLAZE process and finish is identical to that of which AJ Wells use to manufacture the iconic signage and architectural cladding for the London Underground.

VLAZE WALL MOUNTED HEAT SHIELDS are designed to be placed behind the stove. When installed the shield reduces the minimum required distance to the face of the panel to 95mm (and just 75mm in the case of a Charnwood stove). The vitreous enamel panel features a dual skin that provides thermal protection and an effective convection system. Using a rail mounted system they are quick and easy to install. The heat shields are available in 3 sizes to suit all our freestanding stove models.

VLAZE INSERT STOVE SURROUNDS are custom made in one piece to fit around any insert stove. The vitreous enamel panel features a soft radius edge and is insulated with fire rated fibreboard.

VLAZE HEARTH & CHAMBER PLATES create a clean, modern platform on which to stand your stove. An excellent alternative to glass or polished stone they can be used on their own or alongside our heat shields

and insert surrounds for a seamless floor to wall solution. They can also be mounted to the wall behind the stove to line a fireplace chamber. Each hearth features a smooth radius edge and is insulated with fire rated fibreboard to take the heat and weight of the stove while still being light to handle. The plates are available in 5 sizes to suit most stoves and boast a 12mm depth conforming to UK building regulations for non constructional hearths.

The heat shields, insert surrounds and hearth & chamber plates are available in a choice of colours including our standard Black, All White and Basalt. There is also a choice of overlay patterns, textures and designer prints.

VLAZE also produce vitreous enamel furniture, worktops and splashbacks for kitchens and a range of bathroom and wetroom panels. Visit www.vlaze.co for specifications and further details of the full range.



Left clockwise: Heat shield & hearth plate in black. Heat shield & hearth plate in indigo stipple. Heat shield & hearth plate in Voyage Cademuir basalt. Chamber panel in nori, hearth plate in ochre. Above: Vlaze Adapt 240 modular kitchen in quilted graphite and bamboo worktop with splashback in nori

A black dog, possibly a Labrador Retriever, stands on the right side of the frame, looking towards the camera. The background is filled with large agave plants with long, pointed, serrated leaves. The ground is covered in dry leaves and twigs. The sky is clear and blue.

SPECIFICATIONS

FIRES, FACTS AND FIGURES

the ins and outs of our stoves



CRANMORE 5



RATED OUTPUT

5kW to room (range 2-7kW)

NET EFFICIENCY

84%

FLUE OUTLET

Top or Rear **150mm (6")** dia.

MAX LOG LENGTH

300mm (12")

WEIGHT

85KG

MIN DISTANCE TO COMBUSTIBLES

Side: **350mm** Rear: **350mm** With insulated flue & heat shield - Side: **350mm** Rear: **100mm**

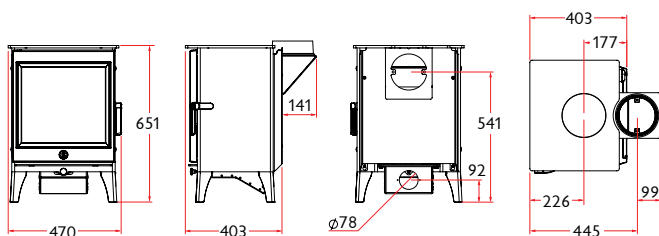

CRANMORE 7



RATED OUTPUT

7kW to room (range 5-11kW)

NET EFFICIENCY

82%

FLUE OUTLET

Top or Rear **150mm (6")** dia.

MAX LOG LENGTH

390mm (15")

WEIGHT

94KG

MIN DISTANCE TO COMBUSTIBLES

Side: **420mm** Rear: **360mm** With insulated flue & heat shield - Side: **390mm** Rear: **110mm**

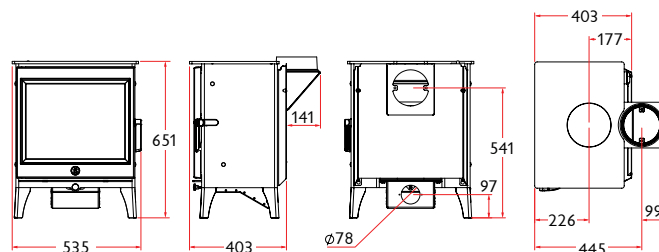

AIRE 3



RATED OUTPUT

3.6kW to room (range 1.5-5kW)

NET EFFICIENCY

86%

FLUE OUTLET

Top or Rear **125mm (5")** dia.

MAX LOG LENGTH

250mm (10")

WEIGHT

62KG Low, **71KG** Store Stand

MIN DISTANCE TO COMBUSTIBLES

Side: **310mm** Rear: **250mm** With insulated flue & heat shield - Side: **310mm** Rear: **100mm**

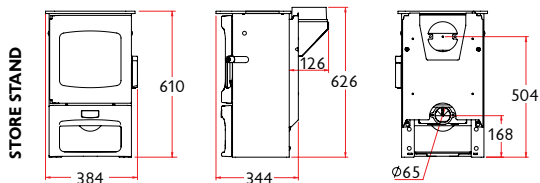
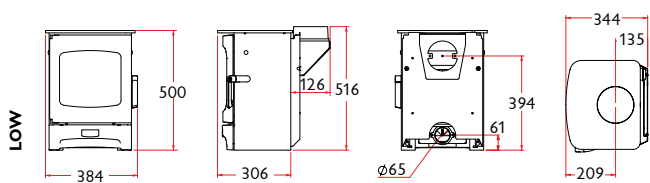

STOVE POD

The Stove Pod is compatible with the Aire 3 only.

WEIGHT (EXC. AIRE 3)

38KG Powdercoat, **47KG** VLAZE Liner

MIN DISTANCE TO COMBUSTIBLES

Rear: **50mm**

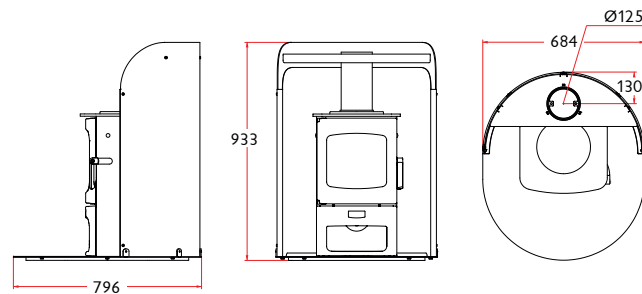

SKYE 5



RATED OUTPUT

5kW to room (range **2-7kW**)

NET EFFICIENCY

86% Wood, 82% Solid Fuel

FLUE OUTLET

Top or Rear **125mm (5")** dia.

MAX LOG LENGTH

350mm (13.5")

WEIGHT

135KG Low, **155KG** Store Stand

MIN DISTANCE TO COMBUSTIBLES

Side: **300mm** Rear: **270mm** With insulated flue & heat shield - Side: **200mm** Rear: **90mm**

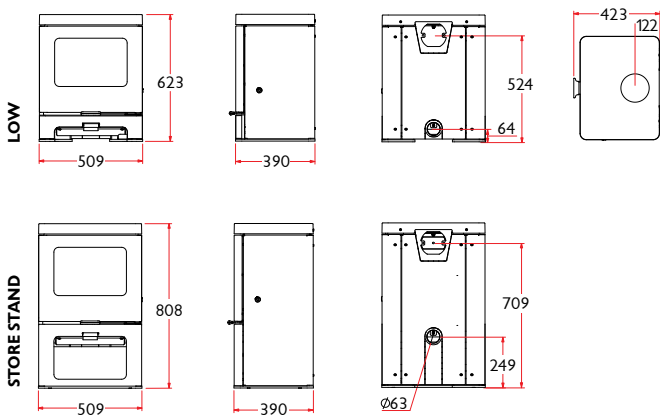

SKYE 7



RATED OUTPUT

7kW to room (range **5-11kW**)

NET EFFICIENCY

80% Wood, 81% Solid Fuel

FLUE OUTLET

Top or Rear **150mm (6")** dia.

MAX LOG LENGTH

410mm (16")

WEIGHT

157KG Low, **177KG** Store Stand

MIN DISTANCE TO COMBUSTIBLES

Side: **350mm** Rear: **350mm** With insulated flue & heat shield - Side: **350mm** Rear: **100mm**

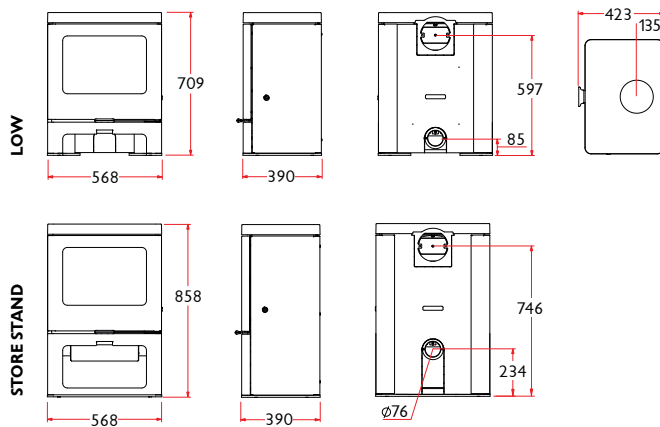

AIRE 5



RATED OUTPUT

5kW to room (range **2-7kW**)

NET EFFICIENCY

84%

FLUE OUTLET

Top or Rear **150mm (6")** dia.

MAX LOG LENGTH

300mm (12")

WEIGHT

109KG Low, **123KG** Store Stand

MIN DISTANCE TO COMBUSTIBLES

Side: **350mm** Rear: **350mm** With insulated flue & heat shield - Side: **350mm** Rear: **100mm**

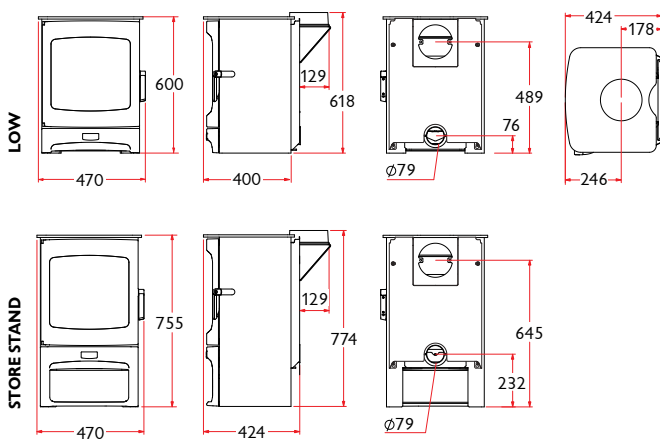

AIRE 7



RATED OUTPUT

7kW to room (range **5-11kW**)

NET EFFICIENCY

82%

FLUE OUTLET

Top or Rear **150mm (6")** dia.

MAX LOG LENGTH

390mm (15")

WEIGHT

117KG Low, **135KG** Store Stand

MIN DISTANCE TO COMBUSTIBLES

Side: **420mm** Rear: **360mm** With insulated flue & heat shield - Side: **390mm** Rear: **110mm**

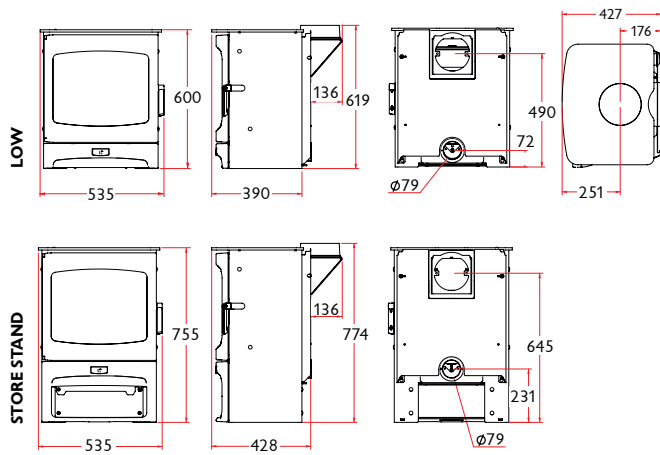

All dimensions in mm

ARC 5



RATED OUTPUT

5kW to room (range **2-7kW**)

NET EFFICIENCY

81% Wood, **82%** Solid Fuel

FLUE OUTLET

Top or Rear **125mm (5")** dia.

MAX LOG LENGTH

285mm (11.5")

WEIGHT

130KG Low, **150KG** Store Stand

MIN DISTANCE TO COMBUSTIBLES

Side: **300mm** Rear: **200mm** With insulated flue & heat shield - Side: **270mm** Rear: **80mm**

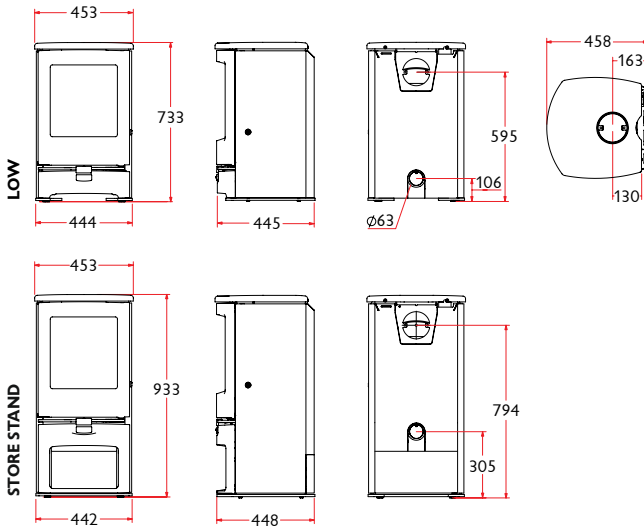

ARC 7



RATED OUTPUT

7kW to room (range **5-11kW**)

NET EFFICIENCY

81% Wood, **79%** Solid Fuel

FLUE OUTLET

Top or Rear **150mm (6")** dia.

MAX LOG LENGTH

325mm (12.5")

WEIGHT

150KG Low, **170KG** Store Stand

MIN DISTANCE TO COMBUSTIBLES

With insulated flue & heat shield - Side: **270mm** Rear: **150mm**

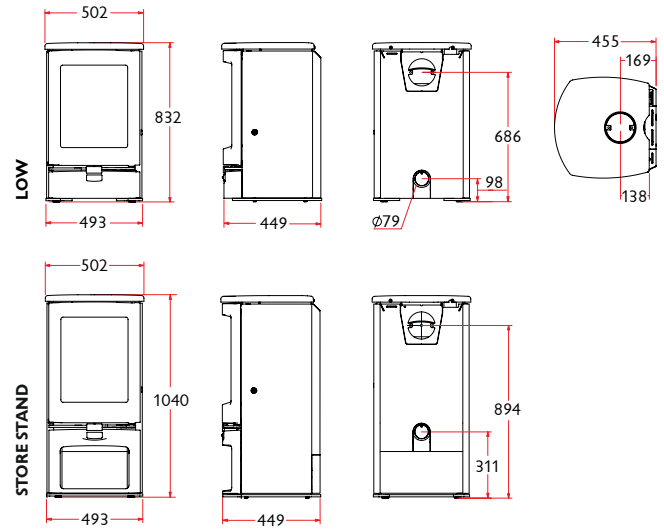

ISLAND I



RATED OUTPUT

5kW to room (range **2-7kW**)

NET EFFICIENCY

85% Wood, **78.8%** Solid Fuel

FLUE OUTLET

Top or Rear **125mm (5")** dia

MAX LOG LENGTH

411mm (16")

MIN DISTANCE TO COMBUSTIBLES

Side: **500mm** Rear: **350mm** With insulated flue & heat shield - Side: **500mm** Rear: **100mm**

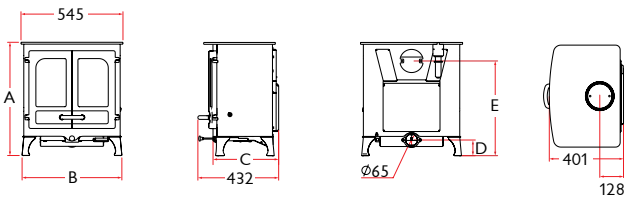

		A	B	C	D	E	WEIGHT
LOW LEGS		611	533	351	85	511	109KG
HIGH LEGS		698	551	329	171	598	110KG
STORE STAND		733	515	300	206	632	117KG

ISLAND II



RATED OUTPUT

8kW to room (range **5-11kW**)

NET EFFICIENCY

82% Wood, **79%** Solid Fuel

FLUE OUTLET

Top or Rear **150mm (6")** dia

MAX LOG LENGTH

480mm (19")

MIN DISTANCE TO COMBUSTIBLES

Side: **480mm** Rear: **500mm** With insulated flue & heat shield - Side: **480mm** Rear: **170mm**

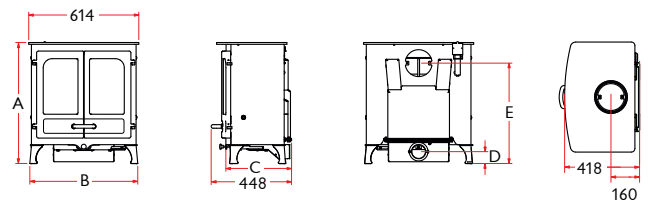

		A	B	C	D	E	WEIGHT
LOW LEGS		675	602	366	66	560	133KG
HIGH LEGS		760	621	330	151	645	134KG
STORE STAND		795	584	299	186	680	140KG

COVE 2



RATED OUTPUT

8kW to room (range 3-11kW)

NET EFFICIENCY

77%

FLUE OUTLET

Top or Rear 150mm (6") dia

MAX LOG LENGTH

414 mm (16")

MIN DISTANCE TO COMBUSTIBLES

Side: 450mm Rear: 600mm With insulated flue, panels & heat shield - Side: 250mm Rear: 250mm

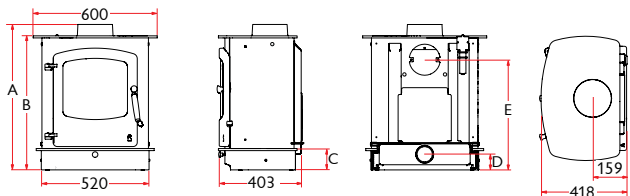

		A	B	C	D	E	WEIGHT
LOW STAND		697	647	103	76	532	127KG
LOW ARCH STAND		697	647	103	76	532	127KG
MIDI STAND		824	774	230	203	659	130KG
STORE STAND		944	894	350	323	779	133KG
CENTRE STAND		944	894	350	323	779	146KG

COVE 3



RATED OUTPUT

12kW to room (range 7-16kW)

NET EFFICIENCY

80%

FLUE OUTLET

Top or Rear 178mm (7") dia

MAX LOG LENGTH

481mm (19")

MIN DISTANCE TO COMBUSTIBLES

Side: 500mm Rear: 600mm With insulated flue, panels & heat shield - Side: 250mm Rear: 250mm

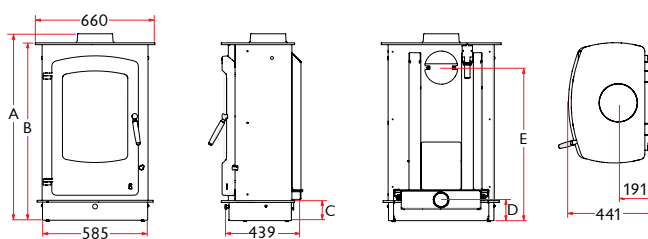

		A	B	C	D	E	WEIGHT
LOW STAND		1030	980	110	115	844	159KG
LOW ARCH STAND		1030	980	110	115	844	159KG
MIDI STAND		1200	1150	280	285	1014	168KG
STORE STAND		1330	1280	410	415	1144	171KG
CENTRE STAND		1330	1280	410	415	1144	187KG

ISLAND III



RATED OUTPUT

11kW to room (range 8-16kW)

NET EFFICIENCY

79%

FLUE OUTLET

Top or Rear 178mm (7") dia

MAX LOG LENGTH

611mm (24")

MIN DISTANCE TO COMBUSTIBLES

Side: 600mm Rear: 600mm With insulated flue, panels & heat shield - Side: 335mm Rear: 335mm

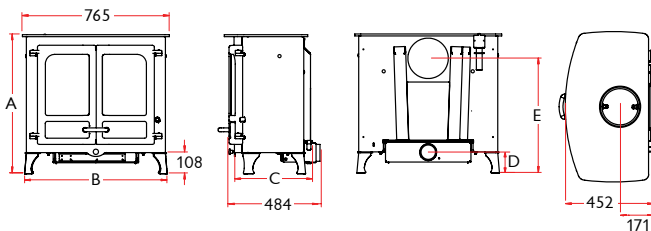

		A	B	C	D	E	WEIGHT
LOW LEGS		713	732	400	107	588	180KG
HIGH LEGS		795	750	400	189	670	184KG
STORE STAND		945	714	309	339	820	197KG



Island III in Almond

BAY VL



RATED OUTPUT

5kW to room (range 2-7kW)

NET EFFICIENCY

81%

FLUE OUTLET

Top only **150mm (6")** dia.

MAX LOG LENGTH

463mm (18")

WEIGHT

94.3KG

MIN DISTANCE TO COMBUSTIBLES

Side: **100mm** Top: **100mm**

See instruction manual for internal casing distances

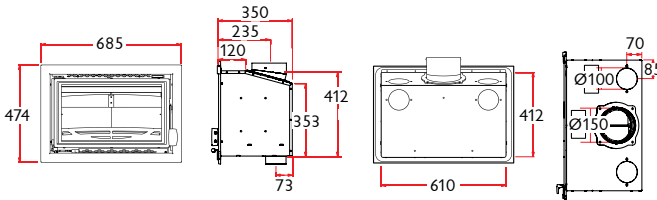

BAY BX



RATED OUTPUT

5kW to room (range 2-7kW)

NET EFFICIENCY

81%

FLUE OUTLET

Top only **150mm (6")** dia.

MAX LOG LENGTH

463mm (18")

MIN DISTANCE TO COMBUSTIBLES

Side: **150mm** Rear: **270mm**

With insulated flue - Side: **100mm** Rear: **130mm**

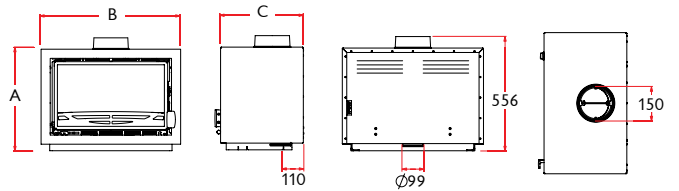

		A	B	C	WEIGHT
FREESTANDING		500	688	403	103KG
STORE STAND		1000	688	500	126KG
CENTRE STAND		910	688	403	136KG
BENCH STAND		1000	1300	500	139KG

C-FOUR



RATED OUTPUT

4.8kW to room (range 2-5.5kW)

NET EFFICIENCY

82%

FLUE OUTLET

Top or Rear **125mm (5")** dia

MAX LOG LENGTH

282mm (11")

MIN DISTANCE TO COMBUSTIBLES

Side: **500mm** Rear: **370mm**

With insulated flue & heat shield - Rear: **175mm**

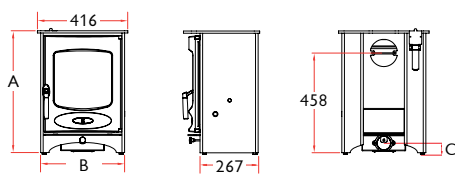

C-FOUR INSERT



RATED OUTPUT

5.0kW to room (range 2-5.5kW)

NET EFFICIENCY

80% Wood, **77%** Solid Fuel

FLUE OUTLET

Top **125mm (5")** dia

MAX LOG LENGTH

332mm (13")

WEIGHT

100KG

MIN DISTANCE TO COMBUSTIBLES

Side: **280mm** Top: **310mm**

See instruction manual for internal casing distances

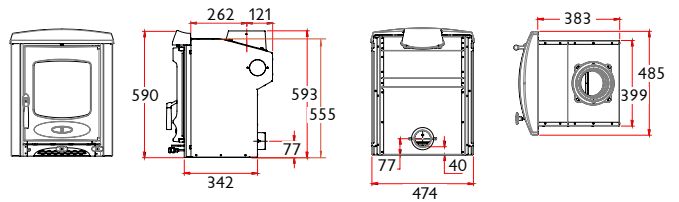

		A	B	C	WEIGHT
LOW LEGS		560	386	45	83KG
STORE STAND		710	386	195	89KG
HIGH LEGS		765	400	248	85.5KG

C-FIVE



RATED OUTPUT

5kW to room (range **2.5-5kW**)

NET EFFICIENCY

82%

FLUE OUTLET

Top or Rear **125mm (5")** dia

MAX LOG LENGTH

351mm (14")

MIN DISTANCE TO COMBUSTIBLES

Side: **500mm** Rear: **400mm**

With insulated flue & heat shield - Rear: **175mm**

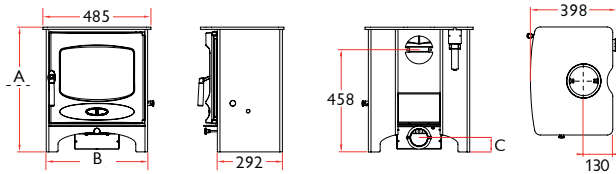

		A	B	C	WEIGHT
LOW LEGS		560	455	65	96KG
STORE STAND		745	455	250	104KG
HIGH LEGS		765	469	268	99.5KG

C-SIX



RATED OUTPUT

5.9kW to room (range **5-7kW**)

NET EFFICIENCY

82%

FLUE OUTLET

Top or Rear **150mm (6")** dia

MAX LOG LENGTH

307mm (12")

MIN DISTANCE TO COMBUSTIBLES

Side: **500mm** Rear: **500mm**

With insulated flue & heat shield - Rear: **200mm**

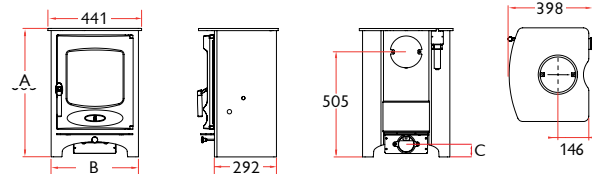

		A	B	C	WEIGHT
LOW LEGS		615	411	63	96KG
STORE STAND		800	411	245	105KG
HIGH LEGS		820	425	265	99.5KG

C-SEVEN



RATED OUTPUT

7.1kW to room (range **6-8kW**)

NET EFFICIENCY

79%

FLUE OUTLET

Top or Rear **150mm (6")** dia

MAX LOG LENGTH

430mm (17")

MIN DISTANCE TO COMBUSTIBLES

Side: **500mm** Rear: **500mm**

With insulated flue & heat shield - Rear: **240mm**

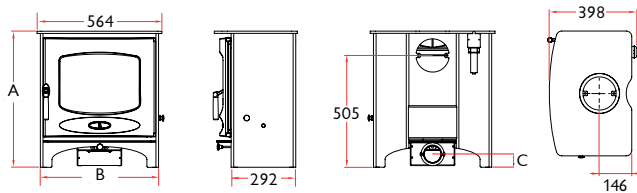

		A	B	C	WEIGHT
LOW LEGS		615	534	59	115KG
STORE STAND		800	534	244	124KG
HIGH LEGS		820	548	269	118.5KG

C-EIGHT



RATED OUTPUT

8kW to room (range **7-9kW**)

NET EFFICIENCY

81%

FLUE OUTLET

Top or Rear **150mm (6")** dia

MAX LOG LENGTH

366mm (14")

MIN DISTANCE TO COMBUSTIBLES

Side: **600mm** Rear: **650mm**

With insulated flue & heat shield - Rear: **250mm**

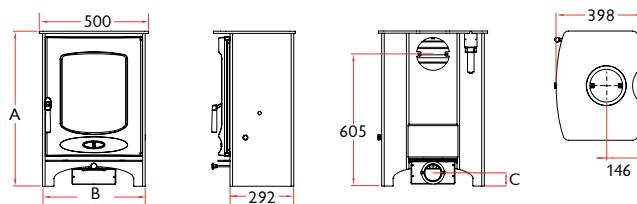

		A	B	C	WEIGHT
LOW LEGS		710	465	61	119KG
STORE STAND		895	470	246	127KG
HIGH LEGS		915	484	268	122.5KG

RATED OUTPUT

5kW to room (range 2-5.5kW)

NET EFFICIENCY

82%

FLUE OUTLET

Top or Rear 125mm (5") dia

MAX LOG LENGTH



351mm (14")

MIN DISTANCE TO COMBUSTIBLES

Side: 500mm Rear: 400mm

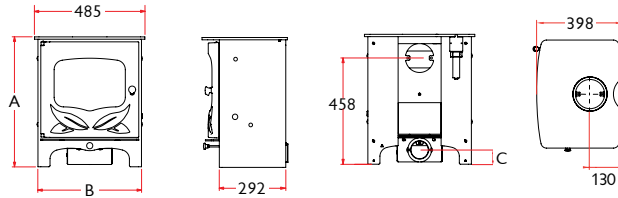
With insulated flue & heat shield - Rear: 175mm



		A	B	C	WEIGHT
LOW LEGS		560	455	65	80KG
STORE STAND		745	455	250	89KG
HIGH LEGS		765	469	268	83.5KG

RATED OUTPUT

5kW to room (range 2-5.5kW)

NET EFFICIENCY

84%

FLUE OUTLET

Top or Rear 125mm (5") dia.

MAX LOG LENGTH

332mm (13")

MIN DISTANCE TO COMBUSTIBLES

Side: 480mm Rear: 550mm

WEIGHT

60kg

With insulated flue & heat shield - Rear: 150mm

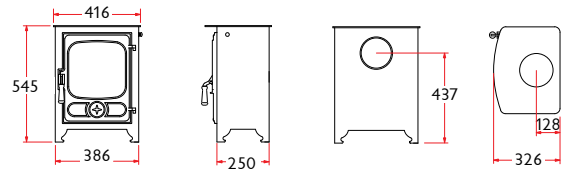

PLEASE NOTE: The stove installations photographed within this brochure are intended as a guide only - Installation must be carried out by a competent engineer in accordance with Building Regulations and local by-laws. Full details are shown in the Installation & Operating Instructions which are available on request. Charnwood's policy is one of continuous development and we reserve the right to change sizes & specifications without notice. All Charnwood stoves have been independently certified to conform to EN 13240:2001 (EN 13229:2001 in the case of the Bay VL and C-Four Insert). All Cranmore, Aire, Skye, Arc, Cove, Island, C-Series and Bembridge stoves meet the UK building requirements for installation with a 12mm non-combustible hearth.





A collection of hand-woven baskets and a woven mat are arranged on a bed of logs and moss. The baskets vary in size and shape, some with wide openings and others more cylindrical. The mat is long and narrow, with a dark blue handle. The background is a natural, rustic setting with logs and green moss.

FIRESIDE ACCESSORIES

COOKING, GIFT IDEAS AND FAIR TRADE FIRESIDE

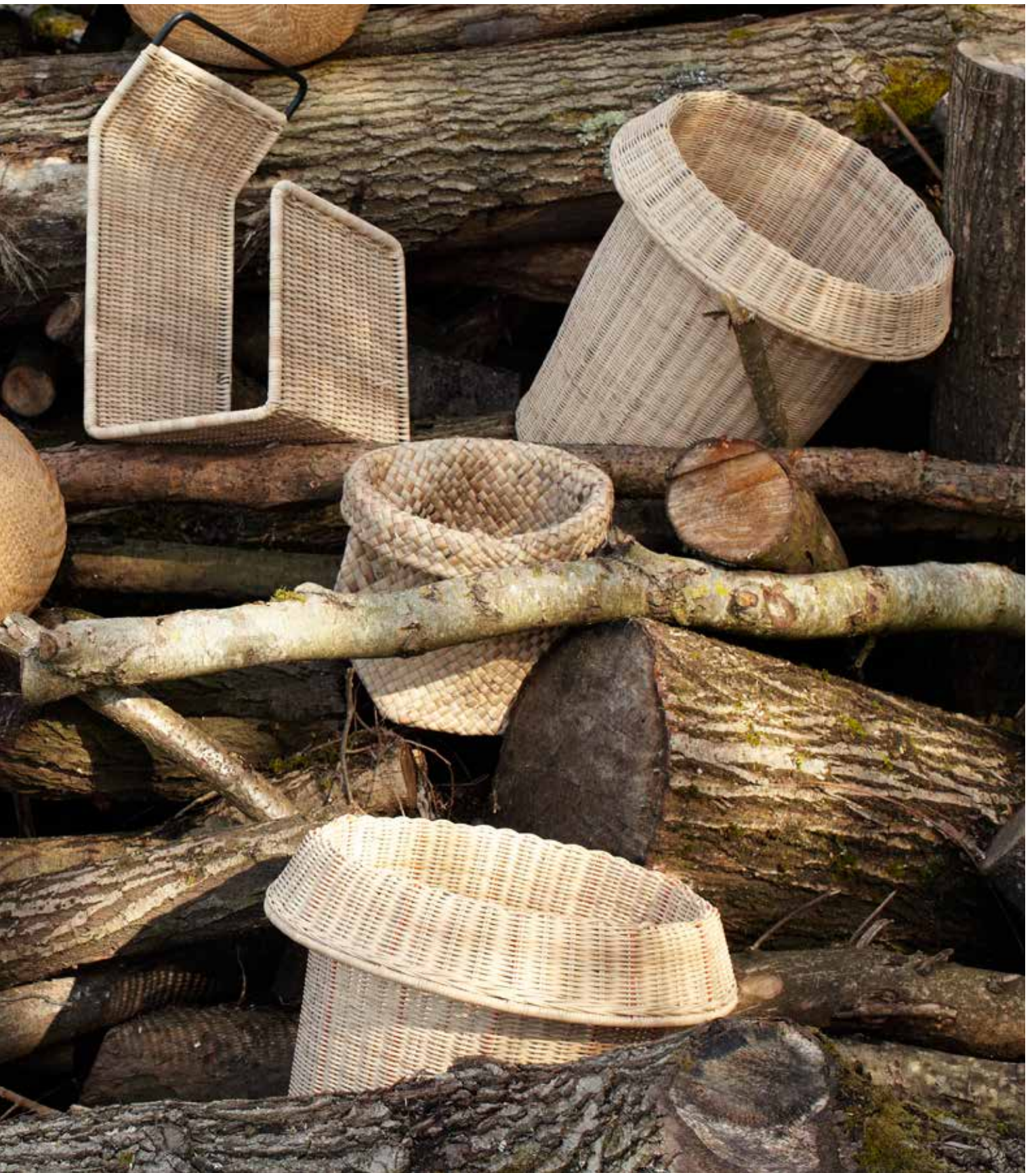

charnwood ACCESSORIES

Charnwood offer a wide range of accessories designed to optimise the performance of your stove and enhance your fireside experience.

MOISTURE METER

Your Charnwood stove is designed to run on seasoned or kiln dried wood. It is very important that the logs you burn have a moisture content of less than 20%.

Use a Charnwood Moisture Meter to check logs are dry and properly seasoned before burning. Insert the prongs into the grain of the wood to determine its moisture content.



ASH-CARRIER

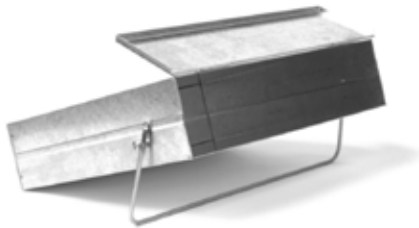

For clean, safe and effective disposal of ash, an optional ash-carrier is available for all our Cranmore, Aire, Skye, Arc, Cove, Island, C-Series, Bembridge, Country 4 models.

STOVE PIPE THERMOMETER

A simple device that attaches to the flue pipe to show the rate at which your stove is burning. This allows you to adjust the fire accordingly so you don't damage your stove by over or underfiring.



TOASTING FORK

The Charnwood Toasting Fork is a neat, highly effective stove accessory designed for use on all Charnwood models.

Simply place the magnetic holder onto the stove top and suspend the fork in front of the glass for perfectly toasted bread, muffins or crumpets. The fork and holder is British made from stainless steel with a turned beech handle.



CHARNWOOD FIRE BALL

The Charnwood Fire Ball (pictured right) is a simple yet effective outdoor fire bowl. This iconic piece is cut from mild steel and supplied as a boxed flat pack kit. When in use we recommend placing the fireball on a non-combustible base such as a concrete paving slab. The Fire Ball will naturally oxidise over time and is designed for outdoor use only.



BODJ FAIR TRADE FIRESIDE

Bodj is a fair trade programme exclusive to Charnwood stoves. The initiative sells a selection of fireside accessories manufactured by a number of small developing businesses in Cambodia, South East Asia. We currently work alongside and support three projects each producing unique products using traditional techniques and from ecologically and locally sourced materials. Our aim is to make a difference to these communities: to actively encourage and celebrate their cultural skills whilst ensuring fair wages and responsible trading practices.

BASKETWARE PROJECT

The Bodj basketware initiative supports a number of basket weaving projects on the outskirts of Phnom Penh and in the Cambodian province of Kratie. A mixture of indigenous materials are used from bamboo and rattan to rush and water hyacinth. Age old weaving techniques are used to create a variety of traditional and adapted designs including log baskets and brushes.

IRONWORK PROJECT

Bodj ironwork products are made by an ironworking initiative based in Phnom Penh. The project trains up a number of young people from disadvantaged backgrounds. Traditional skills are mixed with Khmer inspired designs to create a variety of log holders, companion sets and tools.

RECYCLING PROJECT

The Bodj recycled products are produced by a project based in the Kompong Thom province of Cambodia. Colourful rice sacks are recycled into unstructured log and kindling buckets.

All the Bodj projects are kept deliberately small-scale with working practices within the communities carefully monitored so as not to disturb the eco-system in which the craftspeople live. The production processes of many of the products are also dictated by monsoons therefore availability is sometimes limited. For more information on the full range of products and projects speak to your local stockist or visit bodj.co.uk



Clockwise from left: Fat lip basket, log hoop, large floppy basket, wall mounted companion set, blow poker, lotus log holder, recycled rice sack bucket, small floppy basket and floor standing companion set.



charnwood LIVE FIRE



Charnwood Live Fire is an augmented reality platform that allows you to place a stove in your living room and walk around it to see how it fits into the style of your interior.

Sometimes it's hard to visualise what a stove would look like in your own home. Our Live Fire app is a simple solution to this problem. Just place the *tag* (pictured opposite) in the space where you would like to install the stove, frame it with your smartphone or tablet and then select your stove. Your chosen Charnwood will then appear before you on the screen – fired up and to scale.

Experiment with different colour and stand options and then walk around your chosen stove so you can see it from different angles. You can even take screen shots to email or share online.

The *Charnwood Live Fire* app is free to download and available now from both Apple and Android stores.



Vous pouvez consulter la méthode de téléchargement de CHARNWOOD LIVE FIRE en visitant notre site www.charnwood.fr. Puis, scannez cette page avec votre téléphone ou tablette pour visualiser les poêles et appareils en 3D en réalité augmentée.



Visit www.charnwood.com for instructions on how to download CHARNWOOD LIVE FIRE. Then scan this page with your device to view 3D stoves in augmented reality.

S
LIVE
FIRE
®

charnwood *Bishops Way, Newport, Isle of Wight PO30 5WS, United Kingdom • Tel. +44 (0) 1983 537777 • www.charnwood.com*

